



**ALARIS**  
KUHNE

INSPIRING THE NEXT RF SOLUTION

+49 (0) 9293 - 800 640  
sales@kuhne.alaris.tech  
www.kuhne.alaris.tech  
Scheibenacker 3, 95180 Berg,  
Germany

Version 1.0

# KU LNC 5560 C PRO



## Manual

Directors: Ian Duke/Gustav Wenhold  
Reg no: HRB 3350 Hof, VAT-ID-No: DE 813343044, WEEEReg.-Nr. DE34186665

Kuhne electronic GmbH  
Scheibenacker 3, 95180 Berg  
Germany

A DIVISION OF

**ALARIS**  
THE RF TECHNOLOGY GROUP



## Specifications (Ta = 25 °C):

### Type

### KU LNC 5560 C PRO

Frequency range (RF)  
 Noise figure @ 18 °C  
 Gain (switchable)  
 Output IP3

5500 ... 6000 MHz  
 typ. 1.5 dB, max. 2.0 dB (LO frequency 5200 MHz, IF amplifier enabled)  
 typ. 35 dB (high gain), typ. 17 dB (low gain) (LO frequency 5200 MHz)  
 typ. +25 dBm (high gain), typ. +8 dBm (low gain)

### Switchable LO, IF frequencies

Output frequency (LO 5200, 6300 MHz)  
 Output frequency (LO 5100 MHz)  
 Output frequency (LO 5150 MHz)  
 LO accuracy @ 18 °C  
 LO frequency stability (0 ... 40 °C)

300 ... 800 MHz  
 400 ... 900 MHz  
 350 ... 850 MHz  
 +/- 2 ppm  
 +/- 3 ppm

### Phase noise @ 2040 MHz

@ 1 kHz  
 @ 10 kHz  
 @ 100 kHz

typ. -87 dBc/Hz  
 typ. -91 dBc/Hz  
 typ. -96 dBc/Hz

### Operating parameters

Supply voltage  
 Current consumption  
 Power consumption

+9 ... 36 V DC  
 typ. 180 mA @ 12V (IF amplifier enabled)  
 typ. 2.2 W

### Mechanics

Input connector / impedance  
 Output connector / impedance  
 Case  
 Dimensions (mm)  
 Weight

N-female, 50 ohms  
 BNC-female, 75 ohms  
 milled aluminium, IP41  
 82 x 64 x 22  
 typ. 230 g

### Absolute ratings

Maximum RF input power  
 Operating case temperature range

1 mW (0 dBm)  
 -20 ... +55 °C

### Features

- Low noise figure
- Large bandwidth
- Low phase noise oscillator
- High frequency stability of the oscillator
- High linearity
- Antenna port protected against static discharge
- Small and light-weight to allow easy pole mounting
- Tri-colour LED indicates unit status and gain mode setting
- Overvoltage protection and reverse polarity protection
- Remote power supply via output connector

### Applications

- Multichannel Multipoint Distribution Services (MMDS)
- Digital broadcast systems (DVB-T, DVB-S)
- Analog and digital transmission systems

### CE Konformität / CE Conformity

EMC directive 2014/30/EU  
 Low voltage directive 2014/35/EU  
 RoHS directive 2011/65/EU





## Dimensions / Mounting holes

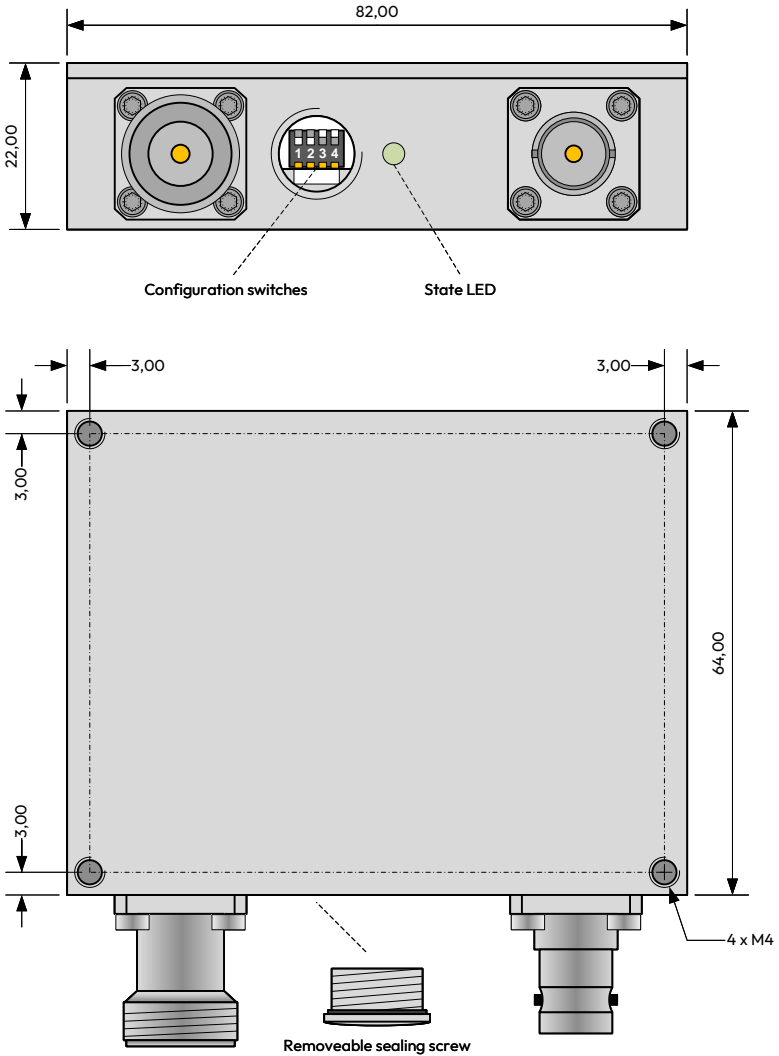

### Configuration Switches / LED state

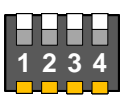

↑ OFF  
 ↓ ON

**Switch 1 + 2 -** (Local oscillator frequency)  
**Switch 3 -** (Gain)  
**Switch 4 -** (User local oscillator frequency)

**Device Error**

**LED state**  
 Red

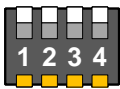

↑ OFF  
 ↓ ON

**Switch 1 - OFF**  
**Switch 2 - OFF**  
 LO 5100 MHz  
 IF 400 ... 900 MHz

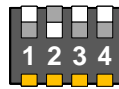

↑ OFF  
 ↓ ON

**Switch 1 - OFF**  
**Switch 2 - ON**  
 LO 6300 MHz  
 IF 800 ... 300 MHz

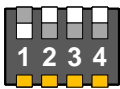

↑ OFF  
 ↓ ON

**Switch 1 - ON**  
**Switch 2 - OFF**  
 LO 5150 MHz  
 IF 350 ... 850 MHz

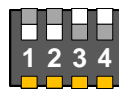

↑ OFF  
 ↓ ON

**Switch 1 - ON**  
**Switch 2 - ON**  
 LO 5200 MHz  
 IF 300 ... 800 MHz

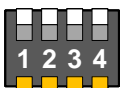

↑ OFF  
 ↓ ON

**Switch 3 - OFF**  
 Low Gain



**LED state**  
 Green

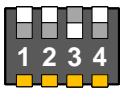

↑ OFF  
 ↓ ON

**Switch 3 - ON**  
 High Gain



**LED state**  
 Blue

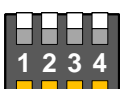

↑ OFF  
 ↓ ON

**Switch 4 - OFF**  
 Local oscillator configuration with Switch 1 + 2

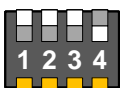

↑ OFF  
 ↓ ON

**Switch 4 - ON**  
 Local oscillator configuration with Switch 1 + 2 disabled  
 User defined local oscillator frequency is enabled

In the case that **Switch 4** is in position **ON** the user defined local oscillator frequency is activated.  
 This user defined local oscillator frequency can be selected in the range from 5000 ... 5200 MHz and from 6300 ... 6400 MHz.  
 The frequency step size of the oscillator frequency is 5 MHz.  
 The user defined oscillator frequency can be programmed with a special programming cable (see next page).

For example the oscillator frequency can be chosen to 5185 MHz .

## Optional Connector PCB

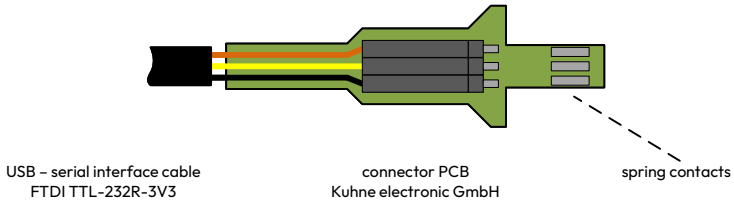

### Configure the user defined local oscillator frequency

- connect the USB – serial interface cable with your PC
- start a terminal program on your PC (for example „hterm“)
- choose the COM port of the USB – serial interface cable

```
BAUDRATE 9600
DATABITS 8
STOPBITS 1
NO FLOW CONTROL
```

- insert the connector PCB with connected USB – serial interface cable into the configuration slot the spring contact must show to the top cover of the down converter
- power up the down converter
- send „s“ with the terminal program to the converter to get the state of the converter

```
Kuhne electronic GmbH - KU LNC 5560 C PRO

PLL locked
GAIN high
Selected LO frequency: 5100 MHz
User defined LO frequency: 5185 MHz
User defined LO frequency enabled
```

- send „5185LO“ with the terminal program to the converter to get set the user defined oscillator frequency to 5185 MHz
- power down the down converter
- remove the connector PCB

## Mounting instructions

All LNCs from Kuhne electronic GmbH are labelled with at least protection class IP41 in accordance with DIN EN 60529, **unless a higher protection class is explicitly indicated in the valid specifications for the protection class on page 2.**

This provides information on the resistance of the unit against unwanted penetration of foreign bodies or moisture into the interior of the unit according to the following provision:

- Protected against granular solid foreign bodies (diameter  $\geq 1$  mm).
- Protection against falling spray up to  $60^\circ$  from vertical

The LNC modules have been designed with maximum protection against moisture. Nevertheless, water may enter the unit due to the design of the RF connectors, which is why some special features should be taken into account during installation.

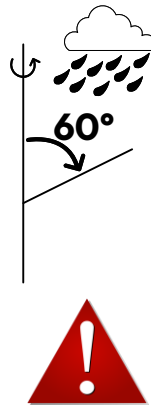
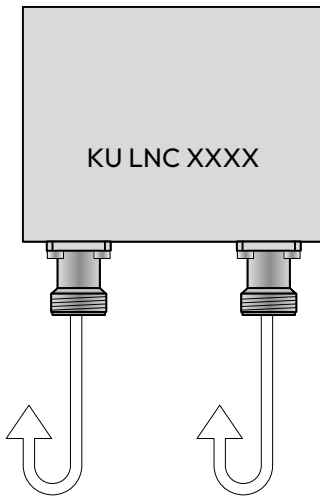

**Mounting with the RF connectors vertically downwards**

**If possible, do not use cable connections with angled elbow connectors, but lead plugs out with a straight cable and a loop pointing downwards.**

In the event of improper installation or handling that does not comply with our recommendations, Kuhne electronic reserves the right to exclude the warranty claim.



## Application diagram

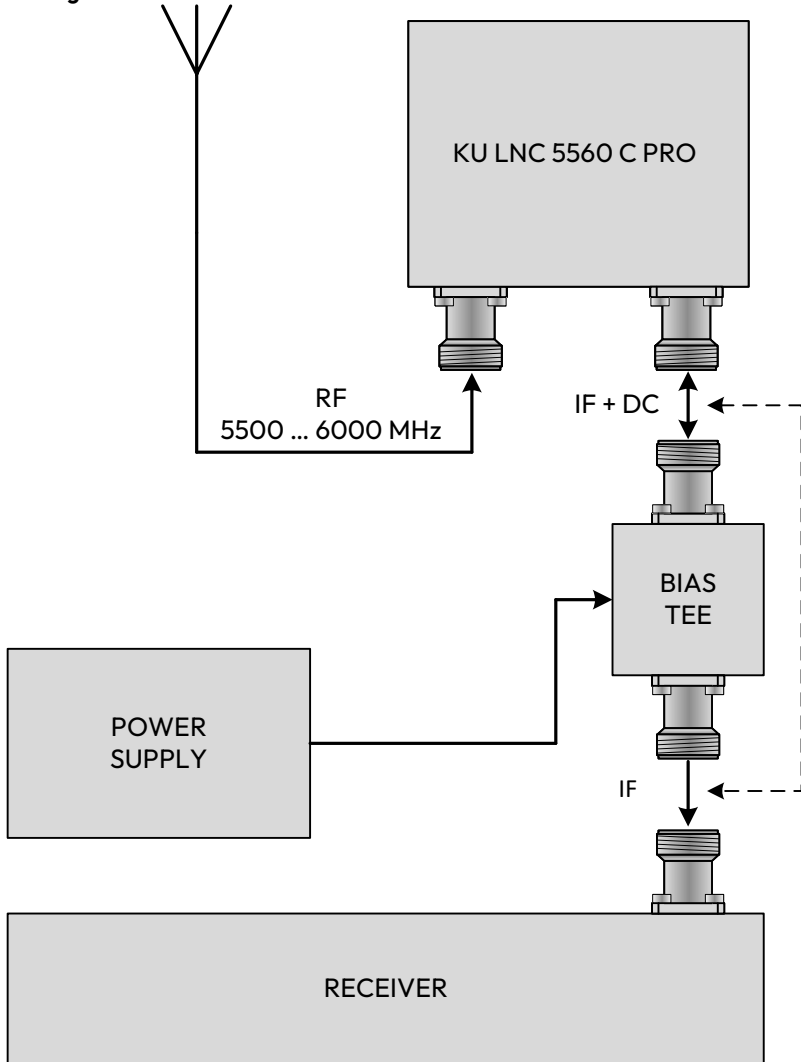

## Typical performance

Typical gain and noise figure  
 (5200 MHz LO frequency, IF amplifier on)

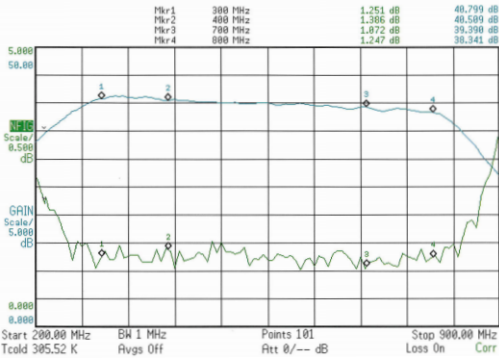

Typical gain and noise figure  
 (5200 MHz LO frequency, IF amplifier off)

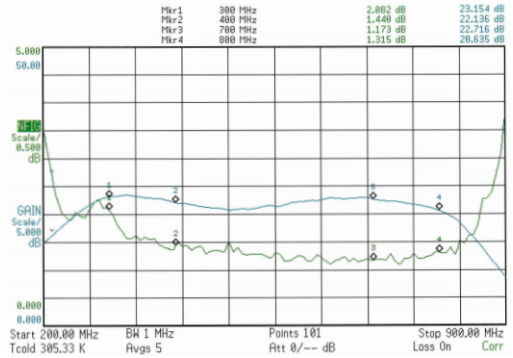

Typical phase noise at 5200 MHz local oscillator frequency

